

2023 GENERAL CATALOGUE

# Bonding Seam Sealing & Welding Machines

# CONTENTS

Catalogue of each model is also available. For further details, please refer to the individual machine catalogue.

TAPE BONDING / SEAM SEALING	
JEUX AI-002	10
JEUX AI-101-IRJ	11
JEUX AI-107	12
JEUX AI-118	13
JEUX AI-101L	14
Selection Guide for JEUX AI-Series	15
JEUX SF-806	18
JEUX SF-828	19
QHP-A08	20
ULTRASONIC WELDING	
JEUX 7510	22
JEUX US-511	23
JEUX US-512	24
LWU-3015-4BT	25
HEAT PRESSING	
JEUX CS-651	27
JEUX CS-652	27
JEUX CS-653	28
JEUX CS-658	28
JEUX CS-662	29
JEUX CS-663	29
JEUX CS-664	30
JEUX CS-671	30
JEUX CS-672	31
JEUX CS-673	31
JEUX CS-674	32
JEUX CS-676	32
JEUX CS-677	33
JEUX CS-680	33
JEUX CS-688	34
JEUX CS-691	34
JEUX CS-693	35
JEUX CS-694	35
JEUX CS-695	36
JEUX CS-696	36
JEUX CS-697	37
JEUX CS-698	37
JEUX CS-700	38
JEUX CS-701	38
JEUX CS-703	39

JEUX CS-704	39
JEUX CS-705	40
JEUX CS-707	40
JEUX CS-708	41
JEUX CS-710	41
JEUX CS-711	42
JEUX CS-715	42
JEUX CS-717	43
JEUX CS-718	43
JEUX CS-719	44
JEUX CS-720	44
JEUX CS-721	45
JEUX CS-722	45
JEUX CS-723	46
JEUX CS-724	46
JEUX CS-727	47
JEUX CS-729	47
JEUX CS-731	48
JEUX CS-732	48
JEUX CS-733	49
JEUX CS-737	49
JEUX CS-738	50
JEUX CS-740	50
JEUX CS-741	51
JEUX CS-745	51
JEUX CS-771	52
JEUX CS-780	52
JEUX CS-782	53
JEUX CS-784	53
JEUX CS-785	54
JEUX CS-786	54
JEUX CS-788	55
JEUX CS-794	55
JEUX CS-795	56
JEUX CS-796	56
Selection Guide for Heat Pressing Machines	57
TESTING MACHINES	
JEUX HT-309	61
JEUX HT-360	62
JEUX TD-100	63
JEUX TD-200	63
Optional Items	64



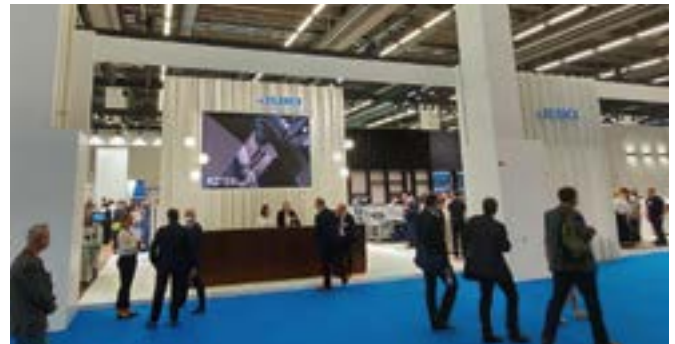

Juki Central Europe (JCE), a subsidiary of Juki Corporation, was established in 2005 as the official body coordinating sales and logistics across twenty European countries as well as Russia, North Africa and Turkey. From the company offices in Warsaw, Poland; sales, marketing, logistics and technical support services are coordinated for the entire extended European market-place. The company's strengths are leveraged through an extensive distributor network that has been established over the years, offering the shared knowledge and expertise of industry leading experts in the sewing sector.

To Juki Central Europe's different offices in Russia, Belarus and Turkey, as well as JUKI Italia S.p.A, in 2022, joined new office in France to expand dynamically our network supporting and maintaining the Juki brand across the continent and beyond.

Juki offers an extensive line of industrial sewing machines for the apparel industry – ranging from Lockstitch, Overlock and Coverstitch machines, to electric bar tackers and automated sewing systems.

In non-apparel industry, the willingness to expand the offer and meet growing customer needs for non-apparel applications prompted us to merge the brands - Juki joined forces with Mitsubishi, which gives more possibility to offer wide ranges of non-apparel machines for variety of needs.

Software solutions such as **JaNets (Juki Advanced Network Systems)** is the next frontier of sewing innovation and aims to bring your production into the future with interlinked machines and data to make analytical decisions.

As well as our extensive range of high quality industrial sewing machines **Juki** produce machines for the semi-professional and home-use market with our home sewers and surgeons establishing themselves as some of the most popular and reliable in the market.

We are very proud of our historically strong distribution network across Europe and throughout the rest of the world. From **Juki Central Europe's offices in Warsaw** and through our representative offices we are able to serve the entire extended European market and North Africa. Through our carefully selected distributors we are able to combine knowledge and specific geographical market

experience to ensure the best sewing solutions are available to customers. Leveraging both our own expertise as well as that of our distributors we are able to provide insights and assistance that can improve end users productivity and quality.

Here in **Juki Central Europe** we constantly have one eye on the future and are looking to improve not only our own business but that of our customers and anyone who uses a **Juki** sewing machine. Our products are developed and manufactured with a consumer viewpoint in-mind at all times and it is our goal to build strong, lasting customer relationships. We will continue to provide products and services by taking our customers' needs and desires into account, by treating our customers as partners, through which we will create value together.

**Juki** was founded in 1938 when nearly 900 independent machinery manufactures came together to form the "TOKYO JUKI MANUFACTURERS ASSOCIATION". It wasn't until 1943 that this association was reorganized into a joint stock corporation. In this time Juki focused on other production types but in 1947 we produced our first sewing machine for the household market. This was followed by the first Juki industrial sewing machine in 1953 and decades of industry dominance thereafter. Juki has been at the forefront of sewing machine innovation over its lifetime with many of our advancements being adopted industry wide. To name just a few of our more famous improvements: the single-axis rotational thread take-up (1957), automatic Thread Trimmer (1969), pick-and-placer (1987), automatic bobbin thread feeder (1997), multifunctional machine digitalization (2015). This is just one milestone for Juki and we look forward to continuing our journey far into the future.

## JUKI NON-SEWING LABORATORY



## JUKI CENTRAL EUROPE WOULD LIKE TO INVITE YOU TO OUR NON-SEWING SHOWROOM!

**The specialized showroom is a one-stop shop for all the new bonding, welding, press and industrial printing machines Juki Central Europe is now able to offer.**

Now that the full range of solutions set up and available to use **in one place** it is the perfect place for you to test out the machines and see what they can do to give an edge to your production process. We have our resident experts on hand to provide detailed explanation and training you can be sure that a visit will be as valuable as possible. With these solutions testing your materials is key and we are able to perform these tests ahead of time again ensuring you will get the most out of your visit.



# WHAT IS A SMART FACTORY?

IT IS VISUALISED

IT IS CONNECTED



Factory management



Production Line Control



Operator Motivation



Connected Supply Chain



Connected factory



Connected Sewing Line

## JUKI SOLUTIONS

01 AUTOMATIZATION



Robot Sewing System

02 DIGITALIZATION



Digital Control

03 NETWORKING



Production Data Collection



Automatic Guided Vehicle



Two-way Communication



Production Output Machine Operation Rate

# INTRO

Depending on the function and process required by a factory there are different methods of bonding that achieve different results or seams. This technology can be used as a replacement for traditional stitch's (attaching fabric to fabric) but also to improve normal stitched seams strength and durability (sealing).

Creation of seams is carried out by a number of different methods but in all process one piece of fabric is fused to another piece. Sealing of seams uses special tape applied over an existing seam (either stitched or bonded) to make it stronger or waterproof.



## Tape Bonding / Seam Sealing

The hot air activates the adhesive of the specialized bonding tape fusing the tape to the fabric. Tape can also be applied on top of normal stitched seams to make them waterproof and more durable.



JEUX AI-107 spec A-NNN



## Ultrasonic Welding

Ultrasonic vibration causes the material to heat up and fuse together. A ultrasonic vibration from the horn cause mechanical stress within the materials that release thermal energy softening the points of contact and bonding the material together. Bonding only takes place at the points of contact between the horn and anvil. Polyester, nylon, polypropylene, polyethylene, PVC, urethane, saran, EVA, and surlyn can all be bonded ultrasonically.



JEUX US-511



## Press Bonding

This uses both a hot and a separate cold plate to create a bond; it is capable of being used to fuse fabric to fabric (attaching) or with join with tape (sealing). Firstly the hot plate is applied to the product and pressure and heat are exerted. This causes the fabric to fuse or bond together (if tape is being used it melts). Secondly the cold plate is applied and this exerts even more pressure on the now melted seam and cools it simultaneously solidifying the bond.



JEUX CS-694



**TAPE BONDING / SEAM SEALING**



## JEUX AI-002

Post-Bed, Seam Sealing Machine with Differential Speed, Memory Function and 3D Electronic Nozzle Positioning System

- Big colour touch panel
- 40 programs memory
- USB data interface
- 3D Electronic nozzle positioning system
- Differential speed top / bottom roller
- Variable speed seam sealing
- Digital tensioning device
- Multi-language support
- Data memory bank

Model name	JEUX AI-002
Power Supply	AC 220 V, 50/60 Hz, 1ϕ
Power Consumption	3600 W
Compressed Air	> 0.4 MPa
Maximum Sealing Speed	18 m/min
Maximum Temperature	800°C
Nozzle Unit	22 mm
Upper Roller Width	25.4 mm
Lower Roller Width	31 mm
Dimensions	1200 x 660 x 1800 mm (LxWxH)
Net Weight	130 kg
Optional Roller	8-30 mm

Possible specifications: A, B, C, D, F, G, I  
\*For ordering options please see page 15

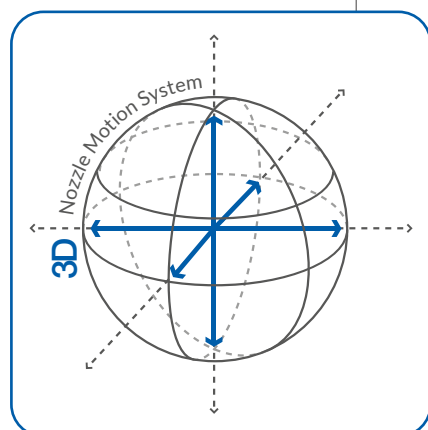

3D Nozzle Positioning



JEUX AI-002 spec A-NNN

## JEUX AI-101-IRJ

Post-Bed, Seam Sealing Machine with Differential Speed, Memory Function, 3D Electronic Nozzle Positioning System and Tape Heating Temperature Controller

- 3D electronic nozzle positioning system
- Tape heating temperature sensor
- Differential speed top / bottom roller
- Variable speed seam sealing
- Color touch screen interface
- Digital tensioning device
- Multi-language software

Model name	JEUX AI-101-IRJ
Power Supply	AC 220 V, 50/60 Hz, 1Φ
Power Consumption	3600 W
Compressed Air	> 0.4 MPa
Maximum Sealing Speed	18 m/min
Maximum Temperature	800°C
Nozzle Unit	22 mm
Upper Roller Width	25.4 mm
Lower Roller Width	31 mm
Dimensions	1200 x 750 x 1800 mm (LxWxH)
Net Weight	160 kg
Optional Roller	8-30 mm

Possible specifications: A, B, I

\*For ordering options please see page 15

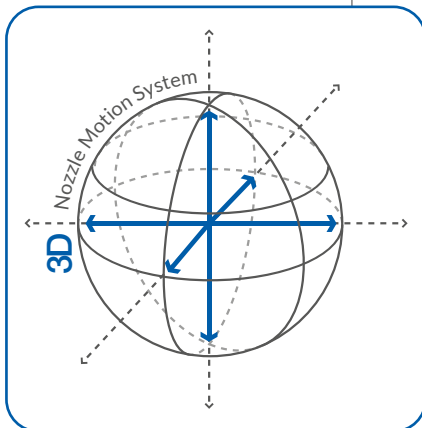

3D Nozzle Positioning



JEUX AI-101

## JEUX AI-107

Post-Bed, Seam Sealing Machine with Differential Speed and Memory Function

- Differential speed top / bottom roller
- Colour touch screen interface
- Digital tensioning device
- Duplex nozzle action

Model name	JEUX AI-107
Power Supply	AC 220 V, 50/60 Hz, 1Φ
Power Consumption	3600 W
Compressed Air	> 0.4 MPa
Maximum Sealing Speed	18 m/min
Maximum Temperature	800°C
Nozzle Unit	22 mm
Upper Roller Width	25.4 mm
Lower Roller Width	31 mm
Dimensions	1200 x 750 x 1800 mm (LxWxH)
Net Weight	150 kg
Optional Roller	8-30 mm

Possible specifications: A, D, I

\*For ordering options please see page 15



JEUX AI-107 spec A-NNN

## JEUX AI-118

### Post-Bed, Seam Sealing Machine with Differential Speed

- Affordable price
- Digital tape feeder (tape tension control)
- Differential speed top/bottom roller
- Digital air pressure display
- Color touch screen interface
- Multi-language software
- USB port
- Easy settings adjustment on big panel

Model name	JEUX AI-118
Power Supply	AC 220 V, 50/60 Hz, 1ϕ
Power Consumption	3600 W
Compressed Air	> 0.4 MPa
Maximum Sealing Speed	24 m/min.
Maximum Temperature	800°C
Nozzle Unit	22 mm
Upper Roller Width	25.4 mm
Lower Roller Width	31 mm
Dimensions	1200 x 750 x 1700 mm (LxWxH)
Net Weight	130 kg
Optional Roller	10-31 mm

Possible specifications: A, I

\*For ordering options please see page 15



JEUX AI-118

# TAPE BONDING / SEAM SEALING

## JEUX AI-101L

### Hot Air Taping Machine For Wide Tape Attaching

- Digital tensioning device
- Differential speed top/bottom roller
- 3D electronic nozzle positioning system
- Automatic fixed length mode
- Digital air pressure display
- Color Touch Screen Interface
- Multi-language support

Model name	JEUX AI-101L
Power Supply	AC 220 V, 50/60 Hz, 1ϕ
Power Consumption	3600 W
Compressed Air	> 0.4 MPa
Maximum Sealing Speed	18 m / min
Maximum Temperature	800°C
Nozzle Unit	22 mm
Upper Roller Width	25.4 mm
Lower Roller Width	31 mm
Dimensions	1200 x 680 x 1800 mm (LxWxH)
Net Weight	160 kg
Optional Roller	10-31 mm

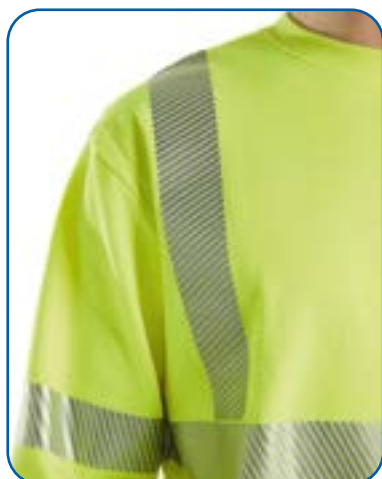

JEUX AI-101L

## SELECTION GUIDE FOR JEUX AI-SERIES

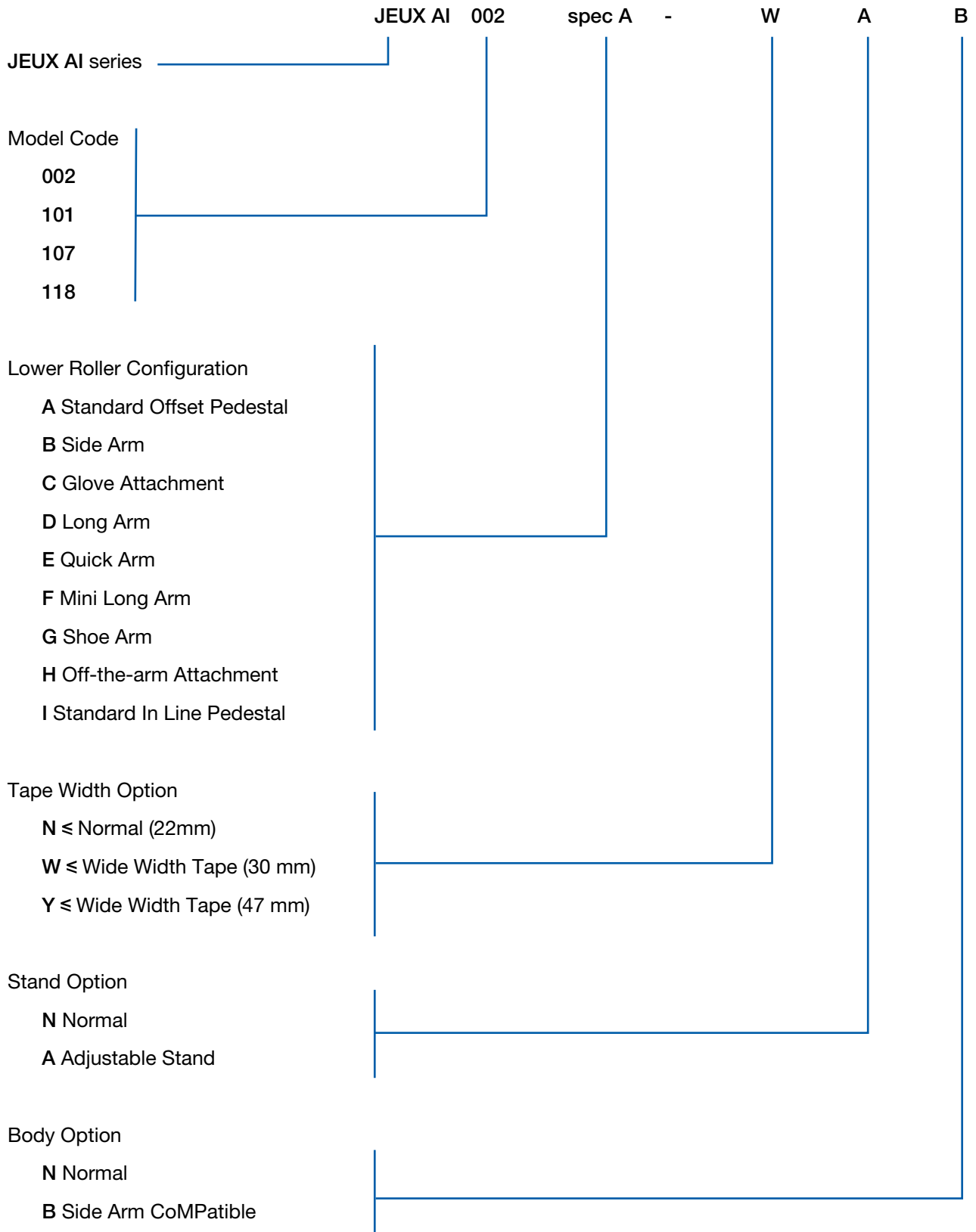

# TAPE BONDING / SEAM SEALING



spec A  
STANDARD OFFSET  
PEDESTAL



spec B  
SIDE ARM



spec C  
GLOVE ATTACHMENT



spec D  
LONG ARM



spec E  
QUICK ARM



spec F  
MINI LONG ARM



spec G  
SHOE ARM



spec H  
OFF-THE-ARM  
ATTACHMENT



spec I  
STANDARD IN LINE  
PEDESTAL

Classified	Item	JEUX AI-002	JEUX AI-101	JEUX AI-107	JEUX AI-118
Features	Power save mode	•	•	•	•
Features	Heat press mode	•	•	•	•
Features	Start / stop seal skip prevention	•	•	•	•
Features	Auto micro reverse	•	•	•	•
Features	Individual program for start / middle / end	•	•	•	•
Features	Error message	•	•	•	•
Features	Working lamp	•	•	•	•
Features	Real time variable speed sealing				
Features	Production statistics	•	•	•	•
Features	Real time clock	•	•		•
Features	Roller cooler	•	•	•	•
Features	Temporary stop pressure release				
Features	Fix length mode	•	•	•	•
Features	USB Disk	•	•		•
Features	Digital pressure indication	•	•	•	•
Control	Multi-function foot switch	•	•	•	
Control	Control pedal number	2	2	2	3
Control	Password protection	•	•	•	•
Control	Touch panel control	•	•	•	•
Control	No. of memory	40	40		5
Control	No. of parameter	44	44	28	21

Classified	Item	JEUX AI-002	JEUX AI-101	JEUX AI-107	JEUX AI-118
Control	Parameter lock	•	•	•	•
Control	No. of controller	2	1	1	1
Control	Temperature deviation (°C)	1	1	1	1
Control	Emulation mode				•
Nozzle	Movement type	Digital Motor	Digital Motor	Pneumatic	Pneumatic
Nozzle	Position adjustment type	Digital Motor	Digital Motor	Mechanical	Mechanical
Nozzle	Movement dimensions	3 Axis	3 Axis	2 Axis	1 Axis
Nozzle	Angle adjustment	•	•	•	•
Nozzle	Digital in / out timing adjustment	•	•		
Nozzle	Oscillation mode	•	•		
Nozzle	Parking position	•	•	•	
Nozzle	Hovering position	•	•	•	
Nozzle	Soft landing movement	•	•		
Nozzle	Calibration mode	•	•		•
Cutter	Hand cut mode	•	•	•	•
Cutter	Foot cut mode	•	•	•	•
Cutter	Precision digital tape feeder	•	•	•	•
Tensioner	Type	Digital	Digital	Digital	Digital
Tensioner	Tape end alarm	•	•	•	•
Tensioner	Tape metering function	•	•	•	•
Transmission	Transmission type	Timing Belt	Timing Belt	Timing Belt	Timing Belt
Transmission	No. of motor	7	6	3	3
Transmission	Speed control	Digital	Digital	Digital	Digital
Transmission	Tolerance	< 1%	< 1%	< 1%	< 1%
Transmission	Changeable bottom roller diameter	•	•		
Transmission	Differential speed top / bottom motor	•	•	•	•
Transmission	Manual reverse rotation	•	•	•	•
Construction	Slant body	•	•	•	•
Construction	Body type	Sheet Metal	Sheet Metal	Sheet Metal	Sheet Metal
Lower Roller Configuration	Spec A - standard offset pedestal	•	•	•	•
Lower Roller Configuration	Spec B - side arm	•	•		
Lower Roller Configuration	Spec C - glove attachment	•	•		•
Lower Roller Configuration	Spec D - long arm	•	•	•	
Lower Roller Configuration	Spec E - quick arm		•		
Lower Roller Configuration	Spec F - mini long arm	•	•		
Lower Roller Configuration	Spec G - shoe arm	•	•		
Lower Roller Configuration	Spec I - standard in line pedestal	•		•	•
Lower Roller Configuration	Spec J - slanted pole			•	
Option	Wide width tape (30 mm)	•	•		
Option	Adjustable stand	•			
Option	Side arm compatible	•	•		
Option	Seam allowance guide	•	•	•	
Option	Narrow tape guide	•	•	•	



## JEUX SF-806

### Sewfree Tape Laydown with Ultrasonic Fabric Edge Trimmer

- 28 kHz quiet operation
- Differential speed top / bottom roller
- Color touch screen interface
- Digital tensioning device
- Adjustable cutter speed
- USB data interface

Model name	JEUX SF-806
Power Supply	AC 220 V, 50/60 Hz, 1Φ
Power Consumption	800 W
Compressed Air	> 0.4 MPa
Maximum Sealing Speed	9 m / min
Maximum Temperature	800°C
Upper Roller Width	25,4 mm
Lower Roller Width	25,4 mm
Dimensions	1200 x 670 x 1420 mm (LxWxH)
Net Weight	128 kg



JEUX SF-806

## JEUX SF-828

### Multifunctional Post-Bed Bonding Machine

- Multifunctional: seam-sealing, overlapping, hemming and binding operations
- Multi-heater ensures adhesive strength
- Differential speed top / bottom roller
- Color touch screen interface
- Automatic tensioning device

Model name	JEUX SF-828
Power Supply	AC 220 V, 50/60 Hz, 1Φ
Heater Power	2680 W
Compressed Air	> 0.4 MPa
Maximum Sealing Speed	5 m / min
Maximum Nozzle Temperature	350°C
Maximum Roller Temperature	250°C
Working Width	6 ~ 20 mm
Dimensions	1220 x 700 x 1450 mm (LxWxH)
Net Weight	130 kg



JEUX SF-828

## TAPE BONDING / SEAM SEALING

### QHP-A08

Post-Bed, Seam-Sealing Machine with Differential Speed and Variable Cylinder / Post Arm

- Shape of air delivery system and rollers make this suitable for curved objects
- The machine arm can register the movements of the operator during bonding and adjust the angle accordingly
- Angle adjustment ensure a smooth and easy operation
- Air temperature can be easily adjusted through the operational interface

Model name	QHP-A08
Power Required	1P/ 200, 220, 240 V 50/60 Hz
Power Consumption	Abt. 2.3 kVA
Nozzle Heater	2.0 kW (200 V)
Nozzle Air Temperature	Up to 750°C
Feed Speed	Max: 10 m / min
Upper Roller	Silicon rubber (30 mm)
Lower Roller	For small diameter tape sealing
Air Consumption	100 litter / min
Arm Type	Variable moving type



Hot air tape bonding machine,  
variable cylinder / post arm



QHP-A08



**ULTRASONIC WELDING**

## JEUX 7510

### Flat Bed Ultrasonic Machine

- A wide range of anvil wheels allows embossing of any profile or welding structure
- No compressed air required
- Newly developed user-interface and custom software
- Cutting and welding functions possible (S Type)
- Flat bed allows for easy and large working area
- Up to 12 m / min welding speed possible
- Automatic roller pressure adjustment

Model name	JEUX 7510-S	JEUX 7510-T
Sonotrode	Steel	Titanium
Frequency	35 kHz	
Sonotrode Standard Size	10 mm	
Maximum welding speed	12 m/min	
User-Interface	7" touch screen	
Power Supply	230 V, 50 Hz	

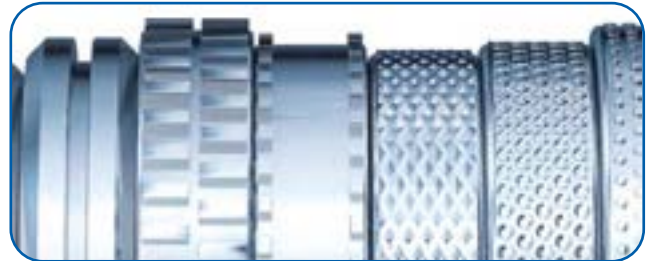

JEUX 7510

## JEUX US-511

### Ultrasonic Rotary Welding Machine

- Automatic Frequency Tracking Ultrasonic System 28 kHz
- Digital Pressure Indicator
- Digital Ultrasonic Frequency Level Indicator
- Programmable Seam Length Programs
- Extra Roller Pressure Controlled From Pedal
- Settings Protection By External Key
- Color Touch Screen Interface
- High Max. Welding Speed
- Suitable For Stretchy Fabrics
- Working On Straight And Curvy Seams
- Customized Welding Wheels For Various Operations
- Affordable Price



Anvil and Sonotrode

Model name	JEUX US-511
Power Supply	AC 220 V, 50/60 Hz, 1Φ
Power Consumption	700 W
Ultrasonic Frequency	28 kHz
Horn Dimension	50 mm
Maximum Welding Speed	20 m / min
Dimensions	1200 x 650 x 1230 mm (LxWxH)
Net Weight	108 kg



JEUX US-511

### OPTIONAL ITEMS

Item Code		
JJBHH2XP	H2XP US-511 CUSTOM MADE ROLLER	
JJBHH2XQ	H2XQ US-511 CUSTOM MADE ROLLER	
JJBHH3D	H3D US-511 CUSTOM MADE ROLLER	
JJBHH3X	H3X US-511 CUSTOM MADE ROLLER	
JJBHH4X	H4X US-511 CUSTOM MADE ROLLER	
JJBHH20H	H20H US-511 CUSTOM MADE ROLLER	
JJBHH40	H40H US-511 CUSTOM MADE ROLLER	

## JEUX US-512

### Ultrasonic Rotary Welding Machine

- Automatic Frequency Tracking Ultrasonic System 35 kHz
- Digital Pressure Indicator
- Programmable Seam Length Programs
- Extra Roller Pressure Controlled From Pedal
- Settings Protection By External Key
- Color Touch Screen Interface
- Suitable For Stretchy Fabrics
- Working On Straight And Curvy Seams
- Customized Welding Wheels For Various Operations
- Affordable Price

Model name	JEUX US-512
Power Supply	AC 220 V, 50/60 Hz, 1Φ
Power Consumption	700 W
Ultrasonic Frequency	35 kHz
Horn Dimension	11 mm
Maximum Welding Speed	8 m / min
Dimensions	1180 x 610 x 1220 mm (LxWxH)
Net Weight	120 kg



Anvil and Sonotrode



JEUX US-512

## LWU-3015-4BT

### Ultrasonic Welding Machine with Variable Cylinder / Post Arm

- The machine uses ultrasonic vibrations to heat fabric, fusing it together
- This machine creates seamless finishing's that are comfortable to wear and allow for high stretchiness
- Perfectly suited for non-woven fabric

Model name	LWU 3015-4BT
Power Required	1P 200 V, 50/60 Hz
Power Consumption	1,0 kVA
Power Output	Max. 600 W
Oscillating Frequency	30 kHz
Feed Speed	0-8.0 m / min (minimum 0,1m / min)
Motor	2 Stepping Motors
Presser	Air Cylinder*
Others	PLC Control / LCD Touch Panel / Control Horn Cooling Device / Air Pressure Detector / Welding Roller Cooling & Blowing Device Touch sensor

\*air compressor is required



LWU-3015-4BT





**HEAT PRESSING**

## JEUX CS-651

### Automatic Cuff Press Machine

- Single or double cuff mode
- Avoid overheating and skipping
- Separate left and right temperature control
- Digitally controlled rotating action
- Color touch screen interface
- Dual time shift mode

Model name	JEUX CS-651
Power Supply	AC 220 V, 50/60 Hz, 1Φ
Heater Power	1500 W
Compressed Air	> 0.4 MPa
Maximum Temperature	260°C
Timing Range	1-999 Seconds
Upper Mold Area	120 x 80 x R50 mm
Lower Mold Area	120 x 73 x R50 mm
Net Weight	650 x 380 x 1120 mm (LxWxH)
Net Weight	68 kg



JEUX CS-651 spec A-A2R2-120073R050

## JEUX CS-652

### Pneumatic Flat Press Machine

- Both hands push button activation for added safety
- Flexible changeable lower platform
- Press travel limiting device
- Optional lighting system
- Foot pedal activation

Model name	JEUX CS-652
Power Supply	AC 220 V, 50/60 Hz, 1Φ
Heater Power	1000 W
Compressed Air	> 0.4 MPa
Maximum Temperature	260°C
Timing Range	1-999 Seconds
Upper Mold Area	206 x 174 mm
Lower Mold Area	203 x 152 mm
Dimensions	520 x 380 x 1050 mm (LxWxH)
Net Weight	45 kg
Extra Lower Mold	150 x 50, Ø68 mm



JEUX CS-652 spec A-A1A1-20015

# HEAT PRESSING

## JEUX CS-653

### Pneumatic Flat Press Machine

- Both hands push button activation for added safety
- Flexible changeable lower platform
- Foot pedal or handle bar activation
- Top plate swing out design
- Dual time shift mode
- Vertical press motion
- Key locking function
- Dual counters

Model name	JEUX CS-653
Power Supply	AC 220 V, 50/60 Hz, 1Φ
Heater Power	1000 W
Compressed Air	> 0.4 MPa
Maximum Temperature	260°C
Timing Range	1-999 Seconds
Upper Mold Area	206 x 174 mm
Lower Mold Area	203 x 152 mm
Dimensions	450 x 560 x 910 mm (LxWxH)
Net Weight	50 kg
Extra Lower Mold	150 x 50, Ø68 mm



JEUX CS-653 spec A-D1M2-020015

## JEUX CS-658

### Pneumatic Flat Heat and Cool Press Machine

- Both hands push button activation for added safety
- Digital pressure and temperature interlock
- Flexible changeable lower platform
- Selectable foot pedal activation
- Key locking supervisor mode
- Dual time shift mode
- Top plate swing out design
- Dual counters & trend display

Model name	JEUX CS-658
Power Supply	AC 220 V, 50/60 Hz, 1Φ
Heater Power	1000 W
Compressed Air	> 0.4 MPa
Maximum Temperature	260°C
Timing Range	1-999 Seconds
Upper Mold Area	380 x 150 mm
Lower Mold Area	380 x 80 mm
Dimensions	710 x 780 x 830 mm (LxWxH)
Net Weight	93 kg



JEUX CS-658 spec A-D2A1-038008

## JEUX CS-662

### Pneumatic Flat Press Machine

- Both hands push button activation for added safety
- Digital pressure and temperature interlock
- Vacuum platform for precise positioning
- Selectable foot pedal activation
- Key locking supervisor mode
- Dual time shift mode
- Dual counters
- Trend display

Model name	JEUX CS-662
Power Supply	AC 380 V, 50/60 Hz, 1Ø
Heater Power	7500 W
Compressed Air	> 0.4 MPa
Maximum Temperature	260°C
Timing Range	1-999 Seconds
Upper Mold Area	1250 x 530 mm
Lower Mold Area	1200 x 500 mm
Dimensions	1350 x 950 x 1470 mm (LxWxH)
Net Weight	590 kg



JEUX CS-662 spec V-A1A1-120050

## JEUX CS-663

### Pneumatic Curve Heat and Cool Press Machine

- Both hands push button activation for added safety
- Digital pressure and temperature interlock
- Flexible changeable lower platform
- Selectable foot pedal activation
- Key locking supervisor mode
- Dual time shift mode
- Top plate swing out design
- Dual counters & trend display

Model name	JEUX CS-663
Power Supply	AC 220 V, 50/60 Hz, 1Ø
Heater Power	600 W
Compressed Air	> 0.4 MPa
Maximum Temperature	260°C
Timing Range	1-999 Seconds
Upper Mold Area	148 x 40 x R83 mm
Lower Mold Area	130 x 40 x R83 mm
Dimensions	710 x 780 x 830 mm (LxWxH)
Net Weight	78 kg



JEUX CS-663 spec A-D2A 1-130040R083

# HEAT PRESSING

## JEUX CS-664

### Pneumatic Flat Press Machine

- Both hands push button activation for added safety
- Digital pressure and temperature interlock
- Unique motorized heat / cool changeover
- Selectable foot pedal activation
- Key locking supervisor mode
- Dual time shift mode
- Dual counters
- Trend display

Model name	JEUX CS-664
Power Supply	AC 220 V, 50/60 Hz, 1Φ
Heater Power	1000 W
Compressed Air	> 0.4 MPa
Maximum Temperature	260°C
Timing Range	1-999 Seconds
Upper Mold Area	340 x 100 mm
Lower Mold Area	300 x 95 mm
Dimensions	510 x 690 x 1400 mm (LxWxH)
Net Weight	110 kg
Extra Lower Mold	150 x 50, Ø68



JEUX CS-664 spec A-D1A1-028016

## JEUX CS-671

### Manual Flat Press Machine

- Top plate swing out design
- Vertical press motion
- Preset heating time
- Manual clamping device
- Timeout buzzer

Model name	JEUX CS-671
Power Supply	AC 220 V, 50/60 Hz, 1Φ
Heater Power	1000 W
Maximum Temperature	260°C
Timing Range	1-999 Seconds
Upper Mold Area	206 x 156 mm
Lower Mold Area	203 x 152 mm
Dimensions	450 x 550 x 600 mm (LxWxH)
Net Weight	36 kg
Extra Lower Mold	150 x 50, Ø68



JEUX CS-671 spec M-D1A1-020015

## JEUX CS-672

### Pneumatic Flat Press Machine

- Press travel limiting device
- Top plate swing out design
- Foot pedal activation
- Vertical press motion
- Preset heating time
- Safety lever

Model name	JEUX CS-672
Power Supply	AC 220 V, 50/60 Hz, 1ϕ
Heater Power	1500 W
Compressed Air	> 0.4 MPa
Maximum Temperature	260°C
Timing Range	1-999 Seconds
Upper Mold Area	305 x 305 mm
Lower Mold Area	300 x 300 mm
Dimensions	650 x 400 x 980 mm (LxWxH)
Net Weight	115 kg



JEUX CS-672 spec A-D1A1-030030

## JEUX CS-673

### Pneumatic Flat Press Machine

- Top plate flip down design
- Foot pedal activation
- Compact body size
- Preset heating time

Model name	JEUX CS-673
Power Supply	AC 220 V, 50/60 Hz, 1ϕ
Heater Power	1300 W
Compressed Air	> 0.4 MPa
Maximum Temperature	260°C
Timing Range	1-999 Seconds
Upper Mold Area	300 x 150 mm
Lower Mold Area	280 x 130 mm
Dimensions	380 x 520 x 465 mm (LxWxH)
Net Weight	35 kg
Extra Lower Mold	150 x 50, ϕ68



JEUX CS-673 spec A-S1A1-028013

# HEAT PRESSING

## JEUX CS-674

### Pneumatic Flat Heat and Cool Press Machine

- Both hands push button activation for added safety
- Swinging heat / cool changeover
- Press travel limiting device
- Foot pedal activation
- Vertical press motion
- Preset heating time
- Safety lever

Model name	JEUX CS-674
Power Supply	AC 220 V, 50/60 Hz, 1Φ
Heater Power	1000 W
Compressed Air	> 0.4 MPa
Maximum Temperature	260°C
Timing Range	1-999 Seconds
Upper Mold Area	205 x 175 mm
Lower Mold Area	210 x 168 mm
Dimensions	430 x 580 x 850 mm (LxWxH)
Net Weight	6 kg
Extra Lower Mold	150 x 50, Ø68



JEUX CS-674 spec A-D2A 1-020015

## JEUX CS-676

### Pneumatic Flat Press Machine

- Both hands push button activation for added safety
- Digital pressure and temperature interlock
- Selectable foot pedal activation
- Key locking supervisor mode
- Dual time shift mode
- Dual counters
- Trend display

Model name	JEUX CS-676
Power Supply	AC 220 V, 50/60 Hz, 1Φ
Heater Power	12000 W
Compressed Air	> 0.4 MPa
Maximum Temperature	260°C
Timing Range	1-999 Seconds
Upper Mold Area	1250 x 830 mm
Lower Mold Area	1200 x 800 mm
Dimensions	1320 x 1300 x 1860 mm (LxWxH)
Net Weight	860 kg



JEUX CS-676 spec A-A1A1-120080 + TA-030

## JEUX CS-677

### Pneumatic Flat Press Machine

- Both hands push button activation for added safety
- Independently heating of upper and lower
- Foot pedal activation
- Dual time shift mode
- Vertical press motion
- Key locking function
- Dual counters

Model name	JEUX CS-677
Power Supply	AC 220 V, 50/60 Hz, 1Φ
Heater Power	2000 W
Compressed Air	> 0.4 MPa
Maximum Temperature	260°C
Timing Range	1-999 Seconds
Upper Mold Area	320 x 90 mm
Lower Mold Area	320 x 90 mm
Dimensions	570 x 430 x 1500 mm (LxWxH)
Net Weight	75 kg



JEUX CS-677 spec B-A 1A1-032009

## JEUX CS-680

### Pneumatic Flat Press Machine

- Both hands push button activation for added safety
- Foot pedal or handle bar activation
- Dual time shift mode
- Top plate swing out design
- Vertical press motion
- Key locking function
- Dual counters
- Trend display

Model name	JEUX CS-680
Power Supply	AC 220 V, 50/60 Hz, 1Φ
Heater Power	1500 W
Compressed Air	> 0.4 MPa
Maximum Temperature	260°C
Timing Range	1-999 Seconds
Upper Mold Area	305 x 305 mm
Lower Mold Area	300 x 300 mm
Dimensions	420 x 700 x 1020 mm (LxWxH)
Net Weight	102 kg



JEUX CS-680 spec A-D1A1-030030



# HEAT PRESSING

## JEUX CS-688

### Pneumatic Flat Press Machine

- Press travel limiting device
- Foot pedal activation
- Vertical press motion
- Preset heating time
- Safety lever

Model name	JEUX CS-688
Power Supply	AC 220 V, 50/60 Hz, 1Φ
Heater Power	900 W
Compressed Air	> 0.4 MPa
Maximum Temperature	260°C
Timing Range	1-999 Seconds
Upper Mold Area	310 x 110 mm
Lower Mold Area	300 x 100 mm
Dimensions	355 x 235 x 750 mm (LxWxH)
Net Weight	18 kg



JEUX CS-688 spec A-A1A1-030010

## JEUX CS-691

### Pneumatic Flat Press Machine

- Both hands push button activation for added safety
- Digital pressure and temperature Interlock
- Selectable foot pedal activation
- Key locking supervisor mode
- Dual time shift mode
- Dual counters
- Temperature trend display

Model name	JEUX CS-691
Power Supply	AC 220 V, 50/60 Hz, 3Φ
Heater Power	12000 W
Cylinder Size φ	250 mm
Compressed Air	> 0.4 MPa
Maximum Temperature	260°C
Timing Range	1-999 Seconds
Upper Mold Area	1250 x 830 mm
Lower Mold Area	1200 x 800 mm
Dimensions	1800 x 1950 x 2050 mm (LxWxH)
Net Weight	970 kg



JEUX CS-691

## JEUX CS-693

### Pneumatic Flat Press Machine

- Both hands push button activation for added safety
- Digital pressure and temperature interlock
- Selectable foot pedal activation
- Key locking supervisor mode
- Dual time shift mode
- Self leveling platform
- Dual counters
- Trend display

Model name	JEUX CS-693
Power Supply	AC 220 V, 50/60 Hz, 1Ø
Heater Power	3600 W
Compressed Air	> 0.4 MPa
Maximum Temperature	260°C
Timing Range	1-999 Seconds
Upper Mold Area	780 x 380 mm
Lower Mold Area	780 x 380 mm
Dimensions	800 x 880 x 1800 mm (LxWxH)
Net Weight	183 kg



JEUX CS-693 spec A-A1A1-078038

## JEUX CS-694

### Pneumatic Flat Press Machine

- Both hands push button activation for added safety
- Press travel limiting device
- Optional lighting system
- Foot pedal activation
- Vertical press motion
- Preset heating time
- Safety lever

Model name	JEUX CS-694
Power Supply	AC 220 V, 50/60 Hz, 1Ø
Heater Power	3600 W
Compressed Air	> 0.4 MPa
Maximum Temperature	260°C
Timing Range	1-999 Seconds
Upper Mold Area	780 x 380 mm
Lower Mold Area	780 x 380 mm
Dimensions	800 x 880 x 1800 mm (LxWxH)
Net Weight	183 kg



JEUX CS-694 spec A-A1A1-078038

# HEAT PRESSING

## JEUX CS-695

### Automatic Twin Bed Flat Press Machine

- Both hands push button activation for added safety
- Digital pressure and temperature interlock
- Unique pneumatic twin bed changeover
- Selectable foot pedal activation
- Key locking supervisor mode
- Trend display
- Dual counters

Model name	JEUX CS-695
Power Supply	AC 220 V, 50/60 Hz, 1Φ
Heater Power	3200 W
Compressed Air	> 0.4 MPa
Maximum Temperature	260°C
Timing Range	1-999 Seconds
Upper Mold Area	300 x 600 mm
Lower Mold Area	300 x 600 mm
Dimensions	1100 x 800 x 1700 mm (LxWxH)
Net Weight	384 kg



JEUX CS-695 spec V-H1M2-030060

## JEUX CS-696

### Pneumatic Flat Press Machine

- Digital temperature controller
- Press travel limiting device
- Vertical press motion
- Preset heating time

Model name	JEUX CS-696
Power Supply	AC 220 V, 50/60 Hz, 1Φ
Heater Power	1000 W
Maximum Temperature	260°C
Timing Range	1-999 Seconds
Upper Mold Area	206 x 174 mm
Lower Mold Area	203 x 152 mm
Dimensions	440 x 560 x 910 mm (LxWxH)
Net Weight	48 kg
Extra Lower Mold	150x50, Ø68 mm



JEUX CS-696 spec A-D1A1-020015

## JEUX CS-697

### Pneumatic Curve Heat and Cool Press Machine

- Both hands push button activation for added safety
- Digital pressure and temperature interlock
- Pneumatic heat /cool changeover
- Selectable foot pedal activation
- Key locking supervisor mode
- Self lock mode
- Dual counters
- Trend display

Model name	JEUX CS-697
Power Supply	AC 220 V, 50/60 Hz, 1Φ
Heater Power	600 W
Compressed Air	> 0.4 MPa
Maximum Temperature	260°C
Timing Range	1-999 Seconds
Upper Mold Area	165 x 66 x R80 mm
Lower Mold Area	160 x 60 x R70 mm
Dimensions	400 x 550 x 1200 mm (LxWxH)
Net Weight	56 kg



JEUX CS-697 spec A-P2A1-160060R070

## JEUX CS-698

### Pneumatic Flat Heat and Cool Press Machine

- Both hands push button activation for added safety
- Digital pressure and temperature interlock
- Unique pneumatic heat /cool changeover
- Selectable foot pedal activation
- Key locking supervisor mode
- Dual time shift mode
- Trend display
- Dual counters

Model name	JEUX CS-698
Power Supply	AC 220 V, 50/60 Hz, 1Φ
Heater Power	1200 W
Compressed Air	> 0.4 MPa
Maximum Temperature	260°C
Timing Range	1-999 Seconds
Upper Mold Area	300x100 mm
Lower Mold Area	300x100 mm
Dimensions	420 x 590 x 1150 mm (LxWxH)
Net Weight	65 kg



JEUX CS-698 spec A-P2A1-030010

## JEUX CS-700

### Pneumatic Long Curve Press Machine

- Both hands push button activation for added safety
- Digital pressure and temperature interlock
- Vacuum platform for precise positioning
- Key locking supervisor mode
- Dual time shift mode
- Trend display
- Dual counters

Model name	JEUX CS-700
Power Supply	AC 220 V, 50/60 Hz, 1 $\Phi$
Heater Power	2100 W
Compressed Air	> 0.4 MPa
Maximum Temperature	260°C
Timing Range	1-999 Seconds
Upper Mold Area	1210 x 70 mm
Lower Mold Area	1210 x 50 mm
Dimensions	1270 x 710 x 1400 mm (LxWxH)
Net Weight	250 kg



JEUX CS-700 spec V-A1A1-121005

## JEUX CS-701

### Pneumatic Flat Press Machine

- Top plate flip down design
- Foot pedal activation
- CoMPact body size
- Preset heating time

Model name	JEUX CS-701
Power Supply	AC 220 V, 50/60 Hz, 1 $\Phi$
Heater Power	400 W
Compressed Air	> 0.4 MPa
Maximum Temperature	260°C
Timing Range	1-999 Seconds
Upper Mold Area	110 x 110 mm
Lower Mold Area	$\Phi$ 100 mm
Dimensions	300 x 490 x 500 mm (LxWxH)
Net Weight	28 kg



JEUX CS-701 spec A-S1A1-D100

## JEUX CS-703

### Pneumatic Flat Press Machine

- Both hands push button activation for added safety
- Digital pressure and temperature interlock
- Vacuum platform for precise positioning
- Selectable foot pedal activation
- Key locking supervisor mode
- Dual time shift mode
- Offset lower platform
- Dual counters

Model name	JEUX CS-703
Power Supply	AC 220 V, 50/60 Hz, 1Ø
Heater Power	3000 W
Compressed Air	> 0.4 MPa
Maximum Temperature	260°C
Timing Range	1-999 Seconds
Upper Mold Area	900 x 230 mm
Lower Mold Area	900 x 70 mm
Dimensions	950 x 740 x 2150 mm (LxWxH)
Net Weight	282 kg



JEUX CS-701 spec A-S1A1-D100

## JEUX CS-704

### Pneumatic Flat Press Machine

- Both hands push button activation for added safety
- Press travel limiting device
- Optional lighting system
- Foot pedal activation
- Vertical press motion
- Preset heating time
- Safety lever

Model name	JEUX CS-704
Power Supply	AC 220 V, 50/60 Hz, 1Ø
Heater Power	2500 W
Compressed Air	> 0.4 MPa
Maximum Temperature	260°C
Timing Range	1-999 Seconds
Upper Mold Area	620 x 420 mm
Lower Mold Area	610 x 410 mm
Dimensions	1250 x 810 x 1170 mm (LxWxH)
Net Weight	195 kg



JEUX CS-704 spec A-A1T2-061041

# HEAT PRESSING

## JEUX CS-705

### Pneumatic Flat Press Machine

- Independent Press Temperature and Time Control
- Unique Workload Completion Statistics System
- Press Travel Limiting Device
- Digital Temperature Controller
- Reliable Safety Lever Design
- Optional Lighting System

Model name	JEUX CS-705
Power Supply	AC 220 V, 50/60 Hz, 1Φ
Heater Power	2600 W
Cylinder Size φ	100 mm
Compressed Air	> 0.4 MPa
Maximum Temperature	260°C
Timing Range	1-999 Seconds
Upper Mold Area	420 x 420 mm
Lower Mold Area	400 x 400 mm
Dimensions	950 x 760 x 1020 mm (LxWxH)
Net Weight	175 kg



JEUX CS-705

## JEUX CS-707

### Pneumatic Flat Cool + Heat Press Machine

- Vertical Motorized Cool/Heat Flip Change Over, High Working Efficiency
- Individual Left, Middle, and Right Zone for More
- Consistent Temperature Control
- Unique Infrared Safety Protection
- Independent Press Temperature Control and Heat / Cool Pressing Time Control
- Added Iron for Auxiliary Positioning
- Unique Workload Completion Statistics System
- Unique Parameter Setting Memory Storage and Reading Function
- Key Locking Supervisor Mode
- Temperature and Pressure Trend Display
- Dual Counters
- Can Set the Relaxed Size, Extruded Size of Elastic Materials, and can Adjust according to Shrinkage

Model name	JEUX CS-707
Power Supply	AC 220 V, 50/60 Hz, 1Φ
Heater Power	3000 W
Cylinder Size φ	160 mm
Compressed Air	> 0.4 MPa
Maximum Temperature	260°C
Timing Range	1-999 Seconds
Upper Mold Area	1500 x 100 mm
Lower Mold Area	1500 x 100 mm
Dimensions	2050 x 1000 x 2600 (LxWxH)
Net Weight	575 kg



JEUX CS-707

\*Water circulator provided as standard, optional chiller

## JEUX CS-708

### Pneumatic Flat Press Machine

- Unique Working Area Pressure & Temperature Logging Function to Ensure Quality Tracking of Finished Product
- Real Time Monitoring of Actual Pressure on Working Area (Patented)
- Both Hands Push Button Activation for Added Safety
- Independently Heating of Upper and Lower
- Selectable Foot Pedal Activation
- Key Locking Supervisor Mode
- Dual Time Shift Mode
- Dual Counters
- Temperature Trend Display

Model name	JEUX CS-708
Power Supply	AC 220 V, 50/60 Hz, 1Ø
Heater Power	3500 W
Cylinder Size $\phi$	125 mm
Compressed Air	> 0.4 MPa
Maximum Temperature	260°C
Timing Range	1-999 Seconds
Upper Mold Area	530 x 310 mm
Lower Mold Area	520 x 300 mm
Dimensions	600 x 600 x 1550 (LxWxH)
Net Weight	120 kg



JEUX CS-708

## JEUX CS-710

### Pneumatic Flat Press Machine

- Both Hands Push Button Activation for Added Safety
- Digital Pressure and Temperature Interlock
- Selectable Foot Pedal Activation
- Key Locking Supervisor Mode
- Dual Time Shift Mode
- Dual Counters
- Temperature Trend Display

Model name	JEUX CS-710
Power Supply	AC 220 V, 50/60 Hz, 1Ø
Heater Power	4500 W
Cylinder Size $\phi$	200 mm
Compressed Air	> 0.4 MPa
Maximum Temperature	260°C
Timing Range	1-999 Seconds
Upper Mold Area	810 x 510 mm
Lower Mold Area	800 x 500 mm
Dimensions	900 x 900 x 1750 (LxWxH)
Net Weight	245 kg



JEUX CS-710



# HEAT PRESSING

## JEUX CS-711

### Pneumatic Flat Press Machine

- Both Hands Push Button Activation for Added Safety
- Digital Pressure and Temperature Interlock
- Foot Pedal or Handle Bar Activation
- Key Locking Supervisor Mode
- Top Plate Swing Out Design
- Dual Time Shift Mode
- Dual Counters
- Temperature Trend Display

Model name	JEUX CS-711
Power Supply	AC 220 V, 50/60 Hz, 1Φ
Heater Power	1700 W
Cylinder Size φ	100 mm
Compressed Air	> 0.4 MPa
Maximum Temperature	260°C
Timing Range	1-999 Seconds
Upper Mold Area	385 x 265 mm
Lower Mold Area	380 x 260 mm
Dimensions	1000 x 700 x 1000 (LxWxH)
Net Weight	13 kg



JEUX CS-711

## JEUX CS-715

### Automatic Pick And Place Label Heat Press Machine

- Both Hands Push Button Activation for Added Safety
- Selectable Foot Pedal Activation
- Precise Motorized Positioning
- Key Locking Supervisor Mode
- Automated Label Handling
- Self Locked Mode
- Dual Counters
- Temperature Trend Display

Model name	JEUX CS-715
Power Supply	AC 220 V, 50/60 Hz, 1Φ
Heater Power	600 W
Cylinder Size φ	63 mm
Compressed Air	> 0.4 MPa
Maximum Temperature	260°C
Timing Range	1-999 Seconds
Upper Mold Area	170 x 130 mm
Lower Mold Area	150 x 110 mm
Arm Range	360 mm
Dimensions	950 x 1300 x 1400 (LxWxH)
Net Weight	120 kg



JEUX CS-715

## JEUX CS-717

### Automatic Pick And Place Label Heat Press Machine

- Both Hands Push Button Activation for Added Safety
- Selectable Foot Pedal Activation
- Precise Motorized Positioning
- Key Locking Supervisor Mode
- Automated Label Handling
- Self Locked Mode
- Dual Counters
- Temperature Trend Display

Model name	JEUX CS-717
Power Supply	AC 220 V, 50/60 Hz, 1Ø
Heater Power	600 W
Cylinder Size $\varnothing$	63 mm
Compressed Air	> 0.4 MPa
Maximum Temperature	260°C
Timing Range	1-999 Seconds
Upper Mold Area	170 x 130 mm
Lower Mold Area	150 x 110 mm
Arm Range	180 mm
Dimensions	1000 x 900 x 1400 (LxWxH)
Net Weight	95 kg



JEUX CS-717

## JEUX CS-718

### Automatic Flat Cool + Heat Press Machine

- Unique Heat and Cool Presses Switching for Precise Positioning
- Digital Control for Consistent Stretching and Rotating
- Both Hands Push Button Activation for Added Safety
- Flexible Foot Pedal Control for Adjusting Material
- Interchangeable Working Platform is Standard
- Digital Pressure and Temperature Interlock
- Infrared Screen Type Protecting Device
- Key Locking Supervisor Mode
- Dual Counters
- Temperature Trend Display

Model name	JEUX CS-718
Power Supply	AC 220 V, 50/60 Hz, 1Ø
Heater Power	3200 W
Cylinder Size $\varnothing$	100 mm
Compressed Air	> 0.4 MPa
Maximum Temperature	260°C
Timing Range	1-999 Seconds
Upper Mold Area	600 x 100 mm
Lower Mold Area	600 x 100 mm
Dimensions	1150 x 850 x 2150 (LxWxH)
Net Weight	360 kg

\*Chiller provided as standard



JEUX CS-718

# HEAT PRESSING

## JEUX CS-719

### Pneumatic Flat Press Machine

- Independent Press Temperature Control and Heat Pressing Time Control
- Unique Workload Completion Statistics System
- Flexible Changeable Lower Platform
- Press Travel Limiting Device
- Digital Temperature Controller
- Reliable Safety Lever Design
- Optional Lighting System

Model name	JEUX CS-719
Power Supply	AC 220 V, 50/60 Hz, 1Φ
Heater Power	3200 W
Cylinder Size φ	125 mm
Compressed Air	> 0.4 MPa
Maximum Temperature	260°C
Timing Range	1-999 Seconds
Upper Mold Area	405 x 405 mm
Lower Mold Area	400 x 400 mm
Dimensions	1730 x 760 x 1500 (LxWxH)
Net Weight	116 kg



JEUX CS-719

## JEUX CS-720

### Pneumatic Flat Press Machine

- Both Hands Push Button Activation for Added Safety
- Digital Pressure and Temperature Interlock
- Selectable Foot Pedal Activation
- Key Locking Supervisor Mode
- Dual Time Shift Mode
- Dual Counters
- Temperature Trend Display

Model name	JEUX CS-720
Power Supply	AC 220 V, 50/60 Hz, 1Φ
Power Consumption	4250 W
Heater Power	3500 W
Vacuum Motor Power	750 W
Cylinder Size φ	125 mm
Compressed Air	> 0.4 MPa
Maximum Temperature	260°C
Timing Range	1-999 Seconds
Upper Mold Area	505 x 505 mm
Lower Mold Area	500 x 500 mm
Dimensions	600 x 800 x 1500 (LxWxH)
Net Weight	143 kg



JEUX CS-720

## JEUX CS-721

### Pneumatic Flat Press Machine

- Independent Press Temperature Control and Heat Pressing Time Control
- Unique Workload Completion Statistics System
- Flexible Changeable Lower Platform
- Press Travel Limiting Device
- Digital Temperature Controller
- Reliable Safety Lever Design
- Optional Lighting System

Model name	JEUX CS-721
Power Supply	AC 220 V, 50/60 Hz, 1Ø
Heater Power	2800 W
Cylinder Size $\phi$	100 mm
Compressed Air	> 0.4 MPa
Maximum Temperature	260°C
Timing Range	1-999 Seconds
Upper Mold Area	600 x 160 mm
Lower Mold Area	600 x 160 mm
Dimensions	660 x 740 x 1460 (LxWxH)
Net Weight	107 kg



JEUX CS-721

## JEUX CS-722

### Pneumatic Flat Press Machine

- Independently Heating of Upper and Lower
- Foot Pedal Activation
- Dual Time Shift Mode
- Vertical Press Motion
- Key Locking Function
- Dual Counters

Model name	JEUX CS-722
Power Supply	AC 220 V, 50/60 Hz, 1Ø
Heater Power	2800 W
Cylinder Size $\phi$	100 mm
Compressed Air	> 0.4 MPa
Maximum Temperature	260°C
Timing Range	1-999 Seconds
Upper Mold Area	610 x 160 mm
Lower Mold Area	610 x 160 mm
Dimensions	700 x 750 x 1530 (LxWxH)
Net Weight	110 kg



JEUX CS-722

# HEAT PRESSING

## JEUX CS-723

### Pneumatic Curve Press Machine

- Both Hands Push Button Activation for Added Safety
- Press Travel Limiting Device
- Foot Pedal Activation
- Vertical Press Motion
- Preset Heating Time
- Safety Lever

Model name	JEUX CS-723
Power Supply	AC 220 V, 50/60 Hz, 1Φ
Power Consumption	1950 W
Heater Power	1200 W
Vacuum Motor Power	750 W
Cylinder Size φ	100 mm
Compressed Air	> 0.4 MPa
Maximum Temperature	260°C
Timing Range	1-999 Seconds
Upper Mold Area	320 x 100 x R195 mm
Lower Mold Area	300 x 95 x R191 mm
Dimensions	730 x 750 x 2020 (LxWxH)
Net Weight	162 kg



JEUX CS-723

## JEUX CS-724

### Pneumatic Curve Press Machine

- Both Hands Push Button Activation for Added Safety
- Digital Pressure and Temperature Interlock
- Selectable Foot Pedal Activation
- Key Locking Supervisor Mode
- Dual Time Shift Mode
- Dual Counters
- Temperature Trend Display

Model name	JEUX CS-724
Power Supply	AC 220 V, 50/60 Hz, 1Φ
Power Consumption	1950 W
Heater Power	1200 W
Vacuum Motor Power	750 W
Cylinder Size φ	100 mm
Compressed Air	> 0.4 MPa
Maximum Temperature	260°C
Timing Range	1-999 Seconds
Upper Mold Area	320 x 100 x R195 mm
Lower Mold Area	300 x 95 x R191 mm
Dimensions	500 x 750 x 1350 (LxWxH)
Net Weight	92 kg



JEUX CS-724N

## JEUX CS-727

### Pneumatic Flat Press

- Both Hands Push Button Activation for Added Safety
- Press Travel Limiting Device
- Automated Label Handling
- Vertical Press Motion
- Preset Heating Time

Model name	JEUX CS-727
Power Supply	AC 220 V, 50/60 Hz, 1Φ
Heater Power	1200 W
Cylinder Size φ	63 mm
Compressed Air	> 0.4 MPa
Maximum Temperature	260°C
Timing Range	1-999 Seconds
Upper Mold Area	210 x 160 mm
Lower Mold Area	200 x 150 mm
Arm Range	200 mm
Dimensions	400 x 700 x 1250 (LxWxH)
Net Weight	50 kg



JEUX CS-727

## JEUX CS-729

### Pneumatic Zipper Press Machine

- Individual Left, Middle, and Right Zone for More Consistent Temperature Control
- Both Hands Push Button Activation for Added Safety
- Digital Pressure and Temperature Interlock
- Unique Motorized Heat/Cool Change Over
- Standard Lower Platform Auxiliary Support
- Infrared Screen Type Protecting Device
- Selectable Foot Pedal Activation
- Key Locking Supervisor Mode
- Dual Time Shift Mode
- Dual Counters
- Temperature Trend Display

Model name	JEUX CS-729
Power Supply	AC 220 V, 50/60 Hz, 1Φ
Power Consumption	2900 W
Heater Power	1800 W
Vacuum Motor Power	1100 W
Cylinder Size φ	125 mm
Compressed Air	> 0.4 MPa
Maximum Temperature	260°C
Timing Range	1-999 Seconds
Upper Mold Area	1060 x 100
Lower Mold Area	1000 x 100
Dimensions	1450 x 1000 x 2650 (LxWxH)
Net Weight	425 kg



JEUX CS-729

\*Chiller provided as standard

# HEAT PRESSING

## JEUX CS-731

### Automatic Pick And Place Label Heat Press Machine

- Both Hands Push Button Activation for Added Safety
- Selectable Foot Pedal Activation
- Precise Motorized Positioning
- Key Locking Supervisor Mode
- Automated Label Handling
- Self Locked Mode
- Dual Counters
- Temperature Trend Display

Model name	JEUX CS-731
Power Supply	AC 220 V, 50/60 Hz, 1Φ
Heater Power	600 W
Cylinder Size φ	63 mm
Compressed Air	> 0.4 MPa
Maximum Temperature	260°C
Timing Range	1-999 Seconds
Upper Mold Area	150 x 100 mm
Lower Mold Area	150 x 100 mm
Arm Range	180 mm
Dimensions	980 x 950 x 1400 (LxWxH)
Net Weight	88 kg



JEUX CS-731

## JEUX CS-732

### Pneumatic Curve Cool + Heat Press Machine

- Standard Hardware Lock, Parameter Locking
- Independent Press Temperature Control and Heat/Cool Pressing Time Control
- Unique Lower Mold Translation Design, Corresponding to Cool and Hot Pressing
- Special Designed Heating Plate, Uniform Temperature
- Vertical Press Motion
- Safety Lever
- Unique Workload Completion Statistics System
- Color Touch Screen Interface
- Multi-language Support

Model name	JEUX CS-732
Power Supply	AC 220 V, 50/60 Hz, 1Φ
Power Consumption	2600 W
Heater Power	1500 W
Vacuum Motor Power	1100 W
Cylinder Size φ	100 mm
Compressed Air	> 0.4 MPa
Maximum Temperature	260°C
Timing Range	1-999 Seconds
Upper Mold Area	340 x 150 x R135
Lower Mold Area	400 x 150 x R125
Dimensions	980 x 980 x 2400 (LxWxH)
Net Weight	275 kg



JEUX CS-732

\*Water circulator provided as standard, optional chiller

## JEUX CS-733

### Pneumatic Double Bed Flat Press

- Both Hands Push Button Activation for Added Safety
- Press Travel Limiting Device
- Lighting System
- Foot Pedal Activation
- Vertical Press Motion
- Preset Heating Time
- Safety Lever

Model name	JEUX CS-733
Power Supply	AC 220 V, 50/60 Hz, 1Φ
Heater Power	1200 W
Cylinder Size φ	63 mm
Compressed Air	> 0.4 MPa
Maximum Temperature	260°C
Timing Range	1-999 Seconds
Upper Mold Area	210 x 160 mm
Lower Mold Area	200 x 150 mm
Dimensions	700 x 600 x 850 (LxWxH)
Net Weight	68 kg



JEUX CS-733

## JEUX CS-737

### Pneumatic Flat Cool + Heat Press Machine

- Both Hands Push Button Activation for Added Safety
- Digital Pressure and Temperature Interlock
- Unique Pneumatic Heat/Cool Change Over
- Selectable Foot Pedal Activation
- Key Locking Supervisor Mode
- Dual Time Shift Mode
- Temperature Trend Display
- Dual Counters

Model name	JEUX CS-737
Power Supply	AC 220 V, 50/60 Hz, 1Φ
Heater Power	1400 W
Cylinder Size φ	100 mm
Compressed Air	> 0.4 MPa
Maximum Temperature	260°C
Timing Range	1-999 Seconds
Upper Mold Area	600 x 160 mm
Lower Mold Area	600 x 160 mm
Dimensions	800 x 700 x 1450 (LxWxH)
Net Weight	125 kg

\*Water circulator provided as standard, optional chiller



JEUX CS-737



# HEAT PRESSING

## JEUX CS-738

### Pneumatic Double Bed Flat Press

- Unique Workload Completion Statistics System
- Independent Time and Temperature Lock Settings
- Key Locking Supervisor Mode
- Add the Left/Right Movement Speed Setting of the Upper Mold
- Unique Motorized Left/Right Movement of the Upper Mold
- Special Design of Buffer Device for Left/Right Movement of the Upper Mold
- Temperature and Pressure Trend Display
- Dual Counters
- Multi-language Support

Model name	JEUX CS-738
Power Supply	AC 220 V, 50/60 Hz, 1Φ
Heater Power	2800 W
Cylinder Size φ	100 mm
Compressed Air	> 0.4 MPa
Maximum Temperature	260°C
Timing Range	1-999 Seconds
Upper Mold Area	600 x 220 mm
Lower Mold Area	150 x 180 x 580 mm
Dimensions	1720 x 1000 x 1550 (LxWxH)
Net Weight	345 kg



JEUX CS-738

## JEUX CS-740

### Pneumatic Curve Cool+ Heat Press Machine

- Both Hands Push Button Activation for Added Safety
- Digital Pressure and Temperature Control
- Pneumatic Heat/Cool Change Over
- Selectable Foot Pedal Activation
- Key Locking Supervisor Mode
- Temperature and Pressure Trend Display
- Multi-language Support
- Self Locked Mode

Model name	JEUX CS-740
Power Supply	AC 220 V, 50/60 Hz, 1Φ
Heater Power	1500 W
Cylinder Size φ	100 mm
Compressed Air	> 0.4 MPa
Maximum Temperature	260°C
Timing Range	1-999 Seconds
Upper Mold Area	345 x 100 x R191 mm
Lower Mold Area	326 x 96 x R181 mm
Dimensions	880 x 700 x 2200 (LxWxH)
Net Weight	128 kg

\*Water circulator provided as standard, optional chiller



JEUX CS-740

## JEUX CS-741

### Pneumatic Flat Cool + Heat Press Machine

- Both Hands Push Button Activation for Added Safety
- Unique Workload Completion Statistics System
- Key Locking Supervisor Mode
- Independent Press Temperature Control and Heat/Cool Pressing Time Control Independent Control of Cool and Heat Pressing Pressure, Adjustable Separately
- Unique Motorized Heat/Cool Change Over
- Temperature Trend Display
- Dual Counters
- Multi-language Support

Model name	JEUX CS-741
Power Supply	AC 220 V, 50/60 Hz, 1Φ
Heater Power	2400 W
Cylinder Size φ	125 mm
Compressed Air	> 0.4 MPa
Maximum Temperature	260°C
Timing Range	1-999 Seconds
Upper Mold Area	310 x 310 mm
Lower Mold Area	300 x 300 mm
Dimensions	680 x 700 x 1950 (LxWxH)
Net Weight	195 kg

\*Chiller provided as standard



JEUX CS-741

## JEUX CS-745

### Pneumatic Flat Cool + Heat Press Machine

- Both Hands Push Button Activation for Added Safety
- Independent Press Temperature Control and Heat/Cool Pressing Time Control
- Precise Control of Pneumatic Cool/Heat Change Over
- Complete Cycle and Incomplete Cycle Counters
- Selectable Foot Pedal Activation
- Chinese and English Display
- Self Locked Mode

Model name	JEUX CS-745
Power Supply	AC 220 V, 50/60 Hz, 1Φ
Heater Power	1200 W
Cylinder Size φ	100 mm
Compressed Air	> 0.4 MPa
Maximum Temperature	260°C
Timing Range	1-999 Seconds
Upper Mold Area	450 x 200 mm
Lower Mold Area	450 x 200 mm
Dimensions	660 x 760 x 1550 (LxWxH)
Net Weight	142 kg

\*Optional chiller



JEUX CS-745

## JEUX CS-771

### Automatic Twin Bed Flat Press Machine

- Precise and Flexible Control of the Left and Right Movement of the Upper Mold
- Key Locking Supervisor Mode, Ensure the Parameters not to be Changed Casually
- Multiple Time Control Settings in the same Workflow
- Press Travel Limiting Device
- Temperature Fluctuation Range can be Locked by the System to Ensure Parameter Consistency
- Working Data Records, Convenient to Check the Machine Temperature and Pressure Change Cycle
- A Variety of Working Modes are Available to Meet the Production Needs to the Greatest Extent
- Complete Cycle and Incomplete Cycle Counters
- With IO Monitoring Settings, Convenient for Engineers to Troubleshoot Machine Faults in Time
- Multi-language Support

Model name	JEUX CS-771
Power Supply	AC 220 V, 50/60 Hz, 1Φ
Heater Power	3500 W
Cylinder Size φ	125 mm
Compressed Air	> 0.4 MPa
Maximum Temperature	260°C
Timing Range	1-999 Seconds
Upper Mold Area	620 x 420 mm
Lower Mold Area	600 x 400 mm
Dimensions	1340 x 750 x 1690 (LxWxH)
Net Weight	300 kg



JEUX CS-771

## JEUX CS-780

### Pneumatic Flat Cool + Heat Press Machine

- Both Hands Push Button Activation for Added Safety
- Complete Cycle and Incomplete Cycle Counters
- Key Locking Supervisor Mode, Ensure the Parameters not to be Changed Casually
- Temperature Fluctuation Range can be Locked by the System to Ensure Parameter Consistency
- Independent Press Temperature Control and Heat/Cool Pressing Time Control
- Stable Pneumatic Cool/Heat Plate Conversion and Translation Control
- Press Travel Limiting Device
- Working Data Records, Convenient to Check the Machine Temperature and Pressure Change Cycle
- With IO Monitoring Settings, Convenient for Engineers to Troubleshoot Machine Faults in Time
- Multi-language Support

Model name	JEUX CS-780
Power Supply	AC 220 V, 50/60 Hz, 1Φ
Heater Power	1600 W
Cylinder Size φ	80 mm
Compressed Air	> 0.4 MPa
Maximum Temperature	260°C
Timing Range	1-999 Seconds
Upper Mold Area	380 x 160 mm
Lower Mold Area	380 x 160 mm
Dimensions	660 x 840 x 1500 (LxWxH)
Net Weight	158 kg

\*Water circulator provided as standard, optional chiller



JEUX CS-780

## JEUX CS-782

### Pneumatic Flat Cool + Heat Press Machine

- Independent press Temperature Control and Heat/ Cool Pressing Time Control
- Both Hands Push Button Activation for Added Safety
- Precise Control of Pneumatic Cool/Heat Change Over
- Complete Cycle and Incomplete Cycle Counters
- Selectable Foot Pedal Activation
- Temperature Trend Display
- Self Locked Mode
- Chinese and English Display

Model name	JEUX CS-782
Power Supply	AC 220 V, 50/60 Hz, 1Ø
Heater Power	1000 W
Cylinder Size $\varphi$	80 mm
Compressed Air	> 0.4 MPa
Maximum Temperature	260°C
Timing Range	1-999 Seconds
Upper Mold Area	300 x 120 mm
Lower Mold Area	300 x 120 mm
Dimensions	600 x 550 x 1300 (LxWxH)
Net Weight	97 kg



JEUX CS-782

## JEUX CS-784

### Pneumatic Flat Cool + Heat Press Machine

- Unique Motorized Heat/Cool Change Over
- Key Locking Supervisor Mode, Ensure the Parameters not to be Changed Casually
- Multiple Working Modes of Heat and Cool Combination
- Both Hands Push Button Activation for Added Safety
- A Variety of Working Modes are Available to Meet the Production Needs to the Greatest Extent
- Complete Cycle and Incomplete Cycle Counters
- With IO Monitoring Settings, Convenient for Engineers to Troubleshoot Machine Faults in Time
- Multi-language Support

Model name	JEUX CS-784
Power Supply	AC 220 V, 50/60 Hz, 1Ø
Heater Power	1000 W
Cylinder Size $\varphi$	80 mm
Compressed Air	> 0.4 MPa
Maximum Temperature	260°C
Timing Range	1-999 Seconds
Upper Mold Area	340 x 100 mm
Lower Mold Area	300 x 95 mm
Dimensions	510 x 690 x 1400 (LxWxH)
Net Weight	110 kg

\*Water circulator provided as standard, optional chiller



JEUX CS-784

## JEUX CS-785

### Pneumatic Flat Cool + Heat Press Machine

- Vertical Heat and Cool Press Working Mode, Higher Efficiency
- Touch Screen Control System, More Convenient and Efficient
- Key Locking Supervisor Mode
- Heat and Cool Plates Working Pressure can be Adjusted Separately
- Unique Motorized Heat/Cool Change Over
- Temperature Trend Display
- Dual Counters
- Self Locked Mode

Model name	JEUX CS-785
Power Supply	AC 220 V, 50/60 Hz, 1Φ
Power Consumption	4200 W
Heater Power	2000 W
Vacuum Motor Power	2200 W
Cylinder Size φ	160 mm
Compressed Air	> 0.4 MPa
Maximum Temperature	260°C
Timing Range	1-999 Seconds
Upper Mold Area	610 x 310 mm
Lower Mold Area	600 x 300 mm
Dimensions	1160 x 840 x 2770 (LxWxH)
Net Weight	437 kg

\*Chiller provided as standard



JEUX CS-785

## JEUX CS-786

### Pneumatic Flat Cool + Heat Press Machine

- Both Hands Push Button Activation for Added Safety
- Multiple Time Control Settings in the Same Workflow
- Independent Press Temperature Control and Heat/Cool Pressing Time Control Precise and Flexible Control of the Forth and Back Movement of the Lower Mold
- A Variety of Working Modes are Available to Meet the Production Needs to the Greatest Extent
- Complete Cycle and Incomplete Cycle Counters
- Key Locking Supervisor Mode, Ensure the Parameters not to be Changed Casually
- Working Data Records, Convenient to Check the Machine Temperature and Pressure Change Cycle
- Multi-language Support

Model name	JEUX CS-786
Power Supply	AC 220 V, 50/60 Hz, 3Φ
Power Consumption	8600 W
Heater Power	4800 W
Vacuum Motor Power	3800 W
Cylinder Size φ	160 mm
Compressed Air	> 0.4 MPa
Maximum Temperature	260°C
Timing Range	1-999 Seconds
Upper Mold Area	1010 x 410 mm
Lower Mold Area	1000 x 400 mm
Dimensions	1500 x 1690 x 2050 (LxWxH)
Net Weight	930 kg

\*Chiller provided as standard



JEUX CS-786

## JEUX CS-788

### Pneumatic Flat Cool + Heat Press Machine

- Multiple Working Modes of Heat and Cool Combination
- Unique Motorized Heat/Cool Change Over
- Horizontal Heat and Cool Press Working Mode, Higher Efficiency
- Reliable Safety Lever Design
- Multiple Time Control Settings in the Same Workflow
- A Variety of Working Modes are Available to Meet the Production Needs to the Greatest Extent
- Unique Workload Completion Statistics System
- Multi-language Support

Model name	JEUX CS-788
Power Supply	AC 220 V, 50/60 Hz, 1ϕ
Heater Power	2000 W
Cylinder Size ϕ	80 mm
Compressed Air	> 0.4 MPa
Maximum Temperature	260°C
Timing Range	1-999 Seconds
Upper Mold Area	460 x 460 mm
Lower Mold Area	450 x 450 mm
Dimensions	870 x 830 x 2270 (LxWxH)
Net Weight	373 kg



JEUX CS-788

## JEUX CS-794

### Pneumatic Flat Cool + Heat Press Machine

- Multiple Working Modes of Heat and Cool Combination
- Reliable Pneumatic Heat/Cool Change Over
- Vertical Heat and Cool Press Working Mode, Higher Efficiency
- Unique Infrared Safety Protection
- A Variety of Working Modes are Available to Meet the Production Needs to the Greatest Extent
- Key Locking Supervisor Mode, Ensure the
- Parameters not to be Changed Casually
- Unique Workload Completion Statistics System
- Multi-language Support

Model name	JEUX CS-794
Power Supply	AC 220 V, 50/60 Hz, 1ϕ
Power Consumption	6150 W
Heater Power	3200 W
Vacuum Motor Power	2200 W
Cylinder Size ϕ	125 mm
Compressed Air	> 0.4 MPa
Maximum Temperature	260°C
Timing Range	1-999 Seconds
Upper Mold Area	1010 x 160 mm
Lower Mold Area	1000 x 160 mm
Dimensions	1390 x 900 x 2390 (LxWxH)
Net Weight	397 kg



JEUX CS-794

\*Chiller provided as standard

# HEAT PRESSING

## JEUX CS-795

### Pneumatic Flat Cool + Heat Press Machine

- Unique Motorized Heat/Cool Change Over
- Key Locking Supervisor Mode, Ensure the Parameters not to be Changed Casually
- Independent Control of Cool and Heat Pressing Pressure, Adjustable Separately
- Both Hands Push Button Activation for Added Safety
- Independent Press Temperature Control and Heat/
- Cool Pressing Time Control
- Temperature and Pressure Trend Display
- Dual Counters
- Unique Workload Completion Statistics System
- Multi-language Support

Model name	JEUX CS-794
Power Supply	AC 220 V, 50/60 Hz, 3Φ
Power Consumption	7800 W
Heater Power	4000 W
Vacuum Motor Power	3800 W
Cylinder Size φ	200 mm
Compressed Air	> 0.4 MPa
Maximum Temperature	260°C
Timing Range	1-999 Seconds
Upper Mold Area	810 x 410 mm
Lower Mold Area	800 x 400 mm
Dimensions	1200 x 900 x 2930 (LxWxH)
Net Weight	637 kg

\*Chiller provided as standard



JEUX CS-795

## JEUX CS-796

### Pneumatic Flat Cool + Heat Press Machine

- Independent Press Temperature and Time Control
- Unique Workload Completion Statistics System
- Press Travel Limiting Device
- Digital Temperature Controller
- Reliable Safety Lever Design
- Optional Lighting System

Model name	JEUX CS-796
Power Supply	AC 220 V, 50/60 Hz, 1Φ
Heater Power	600 W
Cylinder Size φ	80 mm
Compressed Air	> 0.4 MPa
Maximum Temperature	260°C
Timing Range	1-999 Seconds
Upper Mold Area	300 x 100 mm
Lower Mold Area	300 x 100 mm
Dimensions	500 x 560 x 1460 (LxWxH)
Net Weight	77 kg

\*Optional chiller



JEUX CS-796

# SELECTION GUIDE FOR HEAT PRESSING MACHINES

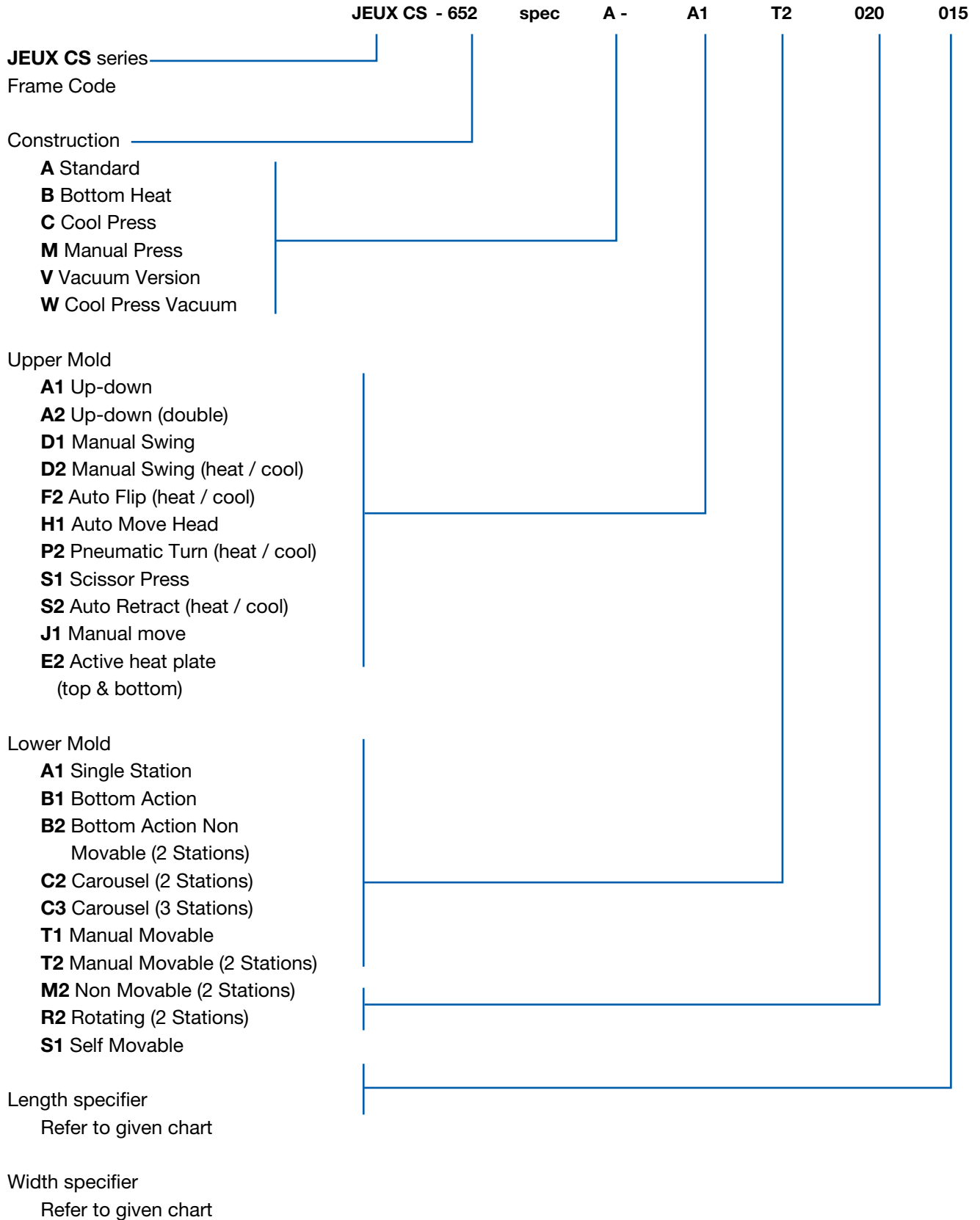



# HEAT PRESSING

Model no.	Lower Mold Area (mm)	Lower Mold Area (inch)	Swing head	Single lower mold	Double lower mold	Economy version	Advance PLC version	Flat press	Curve press	Vacuum version, table included	Heat	Cool	Bottom heat	Cylinder Size $\phi$ (mm)	Lower Mold Pressure (kgf / cm <sup>2</sup> @ 4bar)	Heating Zone no.	Heating Power (W)	Status
JEUX CS-651 spec A-A2R2-073073R033	80x73xR33	3x3xR1.3			•		•		•		•			63	1.19	2	1500	
JEUX CS-651 spec A-A2R2-120073R050	120x73xR50	5x3xR2			•		•		•		•			63	0.73	2	1500	
JEUX CS-651 spec A-A2R2-185073R075	185x73xR75	7x3xR3			•		•		•		•			63	0.47	2	1500	
JEUX CS-652 spec A-A1A1-020015	203x152	8x6		•		•		•			•			63	0.41	1	1000	
JEUX CS-652 spec A-A1T2-020015	203x152	8x6			•	•		•			•			63	0.41	1	1000	
JEUX CS-653 spec A-D1A1-020015	203x152	8x6	•	•			•	•			•			63	0.41	1	1000	
JEUX CS-653 spec A-D1M2-020015	203x152	8x6	•		•		•	•			•			63	0.41	1	1000	
JEUX CS-653 spec B-D1M2-010007	100x70	4x3	•		•		•	•			•		•	63	1.82	2	1800	
JEUX CS-653 spec B-D1M2-020015	203x152	8x6	•		•		•	•			•		•	63	0.41	2	1800	
JEUX CS-654 spec A-A1A1-030030	300x300	12x12		•		•		•			•			100	0.36	1	1200	
JEUX CS-654 spec A-A1T2-030030	300x300	12x12			•	•		•			•			100	0.36	1	1200	
JEUX CS-654 spec A-A1A1-040040	400x400	16x16		•		•		•			•			100	0.20	1	2600	
JEUX CS-655 spec A-A1A1-030030	300x300	12x12		•			•	•			•			100	0.36	1	1500	
JEUX CS-655 spec A-A1T2-030030	300x300	12x12			•		•	•			•			100	0.36	1	1500	
JEUX CS-655 spec B-A1A1-030030	300x300	12x12		•			•	•			•		•	100	0.36	2	3000	
JEUX CS-655 spec V-A1A1-030030	300x300	12x12		•			•	•		•	•			100	0.36	1	1500	
JEUX CS-655 spec A-A1A1-040040	400x400	16x16		•			•	•			•			100	0.20	1	2600	
JEUX CS-655 spec V-A1A1-040040	400x400	16x16		•			•	•		•	•			100	0.20	1	2600	
JEUX CS-658 spec A-D2A1-038008	380x80	15x3	•	•			•	•			•	•		63	0.42	1	1000	
JEUX CS-661 spec A-F2A1-030010	300x95	12x4		•			•	•			•	•		80	0.72	1	1000	
JEUX CS-662 spec A-A1A1-120050	1200x500	48x20		•			•	•			•			200	0.21	3	6000	
JEUX CS-662 spec V-A1A1-120050	1200x500	48x20		•			•	•		•	•			200	0.21	3	6000	
JEUX CS-662 spec W-A1A1-120050	1200x500	48x20		•			•	•		•		•		200	0.21			
JEUX CS-662 spec C-A1A1-120050	1200x500	48x20		•			•	•			•		•	200	0.21			
JEUX CS-663 spec A-D2A1-130040R083	130x40xR83	5x1.5xR3.3	•	•			•		•		•	•		63	2.45	1	600	
JEUX CS-664 spec A-D1A1-028016	280x160	11x6.5	•	•		•		•			•			63	0.28	1	1500	
JEUX CS-665 spec A-A1A1-060012	600x120	24x5		•			•	•			•			100	0.45	1	1600	
JEUX CS-665 spec V-A1A1-060012	600x120	24x5		•			•	•		•	•			100	0.45	1	1600	
JEUX CS-665 spec B-A1A1-060012	600x120	24x5		•			•	•			•		•	100	0.45	2	3200	
JEUX CS-666 spec A-A1A1-060012	600x120	24x5		•		•		•			•			100	0.45	1	1600	
JEUX CS-667 spec A-A1A1-300095R191	300x95xR191	12x4xR7.5		•			•		•		•			80	0.72	1	1200	
JEUX CS-667 spec V-A1A1-300095R191	300x95xR191	12x4xR7.5		•			•		•	•	•			80	0.72	1	1200	
JEUX CS-668 spec A-A1A1-300095R191	300x95xR191	12x4xR7.5		•		•		•			•			80	0.72	1	1200	
JEUX CS-668 spec V-A1A1-300095R191	300x95xR191	12x4xR7.5		•		•		•		•	•			80	0.72	1	1200	
JEUX CS-669 spec A-A1A1-040040	400x400	16x16		•			•	•			•			100	0.20	1	2600	
JEUX CS-669 spec V-A1A1-040040	400x400	16x16		•			•	•		•	•			100	0.20	1	2600	
JEUX CS-671 spec M-D1A1-020015	203x152	8x6	•	•		•		•			•			-		1	1000	
JEUX CS-672 spec A-D1A1-030030	300x300	12x12	•	•		•		•			•			80	0.23	1	1500	
JEUX CS-672 spec A-D1M2-030030	300x300	12x12	•		•	•		•			•			80	0.23	1	1500	
JEUX CS-673 spec A-S1A1-028013	280x130	11x5		•		•		•			•			63	0.35	1	1300	
JEUX CS-674 spec A-D2A1-020015	203x152	8x6	•	•		•		•			•	•		63	0.41	1	1000	

Model no.	Lower Mold Area (mm)	Lower Mold Area (inch)	Swing head	Single lower mold	Double lower mold	Economy version	Advance PLC version	Flat press	Curve press	Vacuum version, table included	Heat	Cool	Bottom heat	Cylinder Size $\phi$ (mm)	Lower Mold Pressure (kgf / cm <sup>2</sup> @ 4bar)	Heating Zone no.	Heating Power (W)	Status
JEUX CS-675 spec A-A1A1-050050	500x500	20x20		•		•	•				•			125	0.20	1	3500	
JEUX CS-676 spec A-A1A1-120080	1200x800	48x32		•			•	•			•			250	0.21	6	12000	
JEUX CS-677 spec B-A1A1-032009	320x90	13x3.5		•			•	•			•		•	63	0.44	2	2000	
JEUX CS-678 spec A-D1B2-050050	500x500	20x20	•		•		•	•			•			224	4.00	1	3500	
JEUX CS-679 spec A-A1A1-011011	110x110	4.5x4.5		•			•	•			•			63	1.05	1	600	
JEUX CS-680 spec A-D1A1-030030	300x300	12x12	•	•			•	•			•			80	0.23	1	1500	
JEUX CS-680 spec A-D1M2-030030	300x300	12x12	•		•		•	•			•			80	0.23	1	1500	
JEUX CS-681 spec V-F2A1-100010	1000x100	40x4		•			•	•		•	•	•		125	0.50	1	1800	
JEUX CS-682 spec V-S2B1-100050	1000x500	40x20		•			•	•		•	•	•		160	3.28	3	7500	
JEUX CS-686 spec A-F2A1-030030	300x300	12x12		•			•	•			•	•		100	0.36	1	2400	
JEUX CS-687 spec V-F2A1-060030	600x300	24x12		•			•	•		•	•	•		160	0.44	1	3200	
JEUX CS-688 spec A-A1A1-030010	300x100	12x4		•		•		•			•			50	0.26	1	900	
JEUX CS-693 spec A-A1A1-078038	780x380	30x15		•			•	•			•			160	0.28	3	3000	
JEUX CS-693 spec V-A1A1-078038	780x380	30x15		•			•	•		•	•			160	0.28	3	3000	
JEUX CS-694 spec A-A1A1-078038	780x380	30x15		•		•		•			•			160	0.28	1	3600	
JEUX CS-695 spec V-H1M2-030060	300x600	12x24			•		•	•		•	•			100	0.18	2	2400	
JEUX CS-696 spec A-D1A1-020015	203x152	8x6	•	•		•		•			•			63	0.41	1	1000	
JEUX CS-697 spec A-P2A1-160060R070	160x60xR70	6.5x2.5xR3		•			•		•		•	•		80	2.14	1	600	
JEUX CS-698 spec A-P2A1-030010	300x100	12x4		•			•	•			•	•		80	0.68	1	1200	
JEUX CS-700 spec V-A1A1-121005	1210x50	48x2		•			•		•	•	•			100	0.53	3	2100	
JEUX CS-701 spec A-S1A1-D70	D70	D3		•		•		•			•			50	1.73	1	400	
JEUX CS-702 spec A-E2P2-011020	110x200	4.5x8		•			•	•			•			80	0.47	4	2400	
JEUX CS-703 spec V-A1M2-090007	900x70	36x3			•		•	•		•	•			125	0.40	3	3000	
JEUX CS-704 spec A-A1T2-061041	610x410	24x16			•	•		•			•			125	0.2	1	2500	



**TESTING MACHINES**

## JEUX HT-309

### Hydrostatic Tester

- Adjustable in / out water flow rate
- Quick release hand clamp
- Direct pressure read out
- Recycling water supply
- Slant test platform
- Hand free testing
- Digital timer

Model name	JEUX HT-309
Power Supply	AC 220 V, 50/60 Hz, 1Φ
Power Consumption	500 W
Maximum Pressure	6 PSI
Timing Range	1-999 Seconds
Dimensions	1000 x 500 x 1350 mm (LxWxH)
Net Weight	40 kg



JEUX HT-309

## JEUX HT-360

### Hydrostatic Tester

- Adjustable in / out water flow rate
- Water temperature high alarm
- Quick release hand clamp
- Direct pressure read out
- Recycling water supply
- Slant test platform
- Hand free testing
- Digital timer

Model name	JEUX HT-360
Power Supply	AC 220 V, 50/60 Hz, 1Φ
Heater Power	370 W
Maximum Pressure	30 psi
Timing Range	1-999 Seconds
Dimensions	1000 x 500 x 1350 mm (LxWxH)
Net Weight	65 kg



JEUX HT-360

## JEUX TD-100

### Portable Bonding Press Station

- Ergonomic handle design
- Heating plate can positioned vertically
- Digital temperature controller

Model name	JEUX TD-100
Power Supply	AC 220 V, 50/60 Hz, 1ϕ
Heater Power	100 W
Maximum Temperature	260°C
Dimensions	330 x 160 x 230 mm (LxWxH)
Net Weight	6 kg



JEUX TD-100

## JEUX TD-200

### Portable Roller Spotting Station

- Heating roller can suspended placed
- Digital temperature controller
- CoMPact body size

Model name	JEUX TD-200
Power Supply	AC 220 V, 50/60 Hz, 1ϕ
Heater Power	200 W
Maximum Temperature	260°C
Roller Diameter	30 mm
Dimensions	170 x 120 x 260 mm (LxWxH)
Net Weight	2 kg



JEUX TD-200

## OPTIONAL ITEMS

---

### NOZZLES



### ROLLERS



### TAPES



Juki Italia S.p.A.  
Via Bergamo 4 • 20045 Lainate (MI)  
Tel: 02 937579.1  
[www.juki.it](http://www.juki.it) • e-mail: [info@juki.it](mailto:info@juki.it)